

Varenummer: 03449055
 Beskrivelse: Fluro Heavy Duty Ledleje GE 55 SWE
 Hul Ø55
 Note: 55

Mål

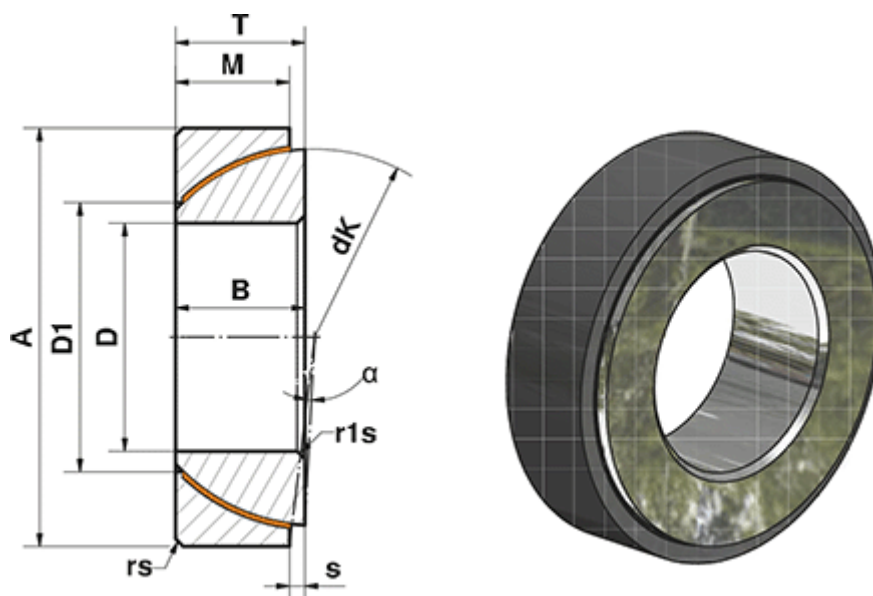

A	= 90	rs, r1s min	= 1
a (grader)	= 4	S	= 5
B	= 23	Statisk belastning C0 (kN)	= 681
D	= 55	T	= 23
D1	= 62.7	Vægt (g)	= 645
dK	= 82		
Dynamisk belastning C (kN)	= 408		
M	= 20		